

THE WINSTON GROUP LTD

1092 Carolina Drive, Unit 1
West Chicago, Illinois 60185
www.winstongroup.com

Ph: 630-231-0419
Fax: 630-231-0429
E-Mail: sales@winstongroup.com

OPERATING INSTRUCTIONS FOR THE EAGLE TALON 4000 HOT-AIR WELDING TOOL

CONGRATULATIONS! You have purchased an Eagle, a tool that is designed and manufactured to assist you with a quality seam weld. NOTE: The Winston Group does not warrant seam performance. We supply a tool which provides heat, speed, and pressure. You, as the operator, select the correct combination of these three components and, like all tools, the most important factor to a quality seam is your skill and experience in setting up and using the Eagle.

READ THESE INSTRUCTIONS. Any new tool requires familiarity. Take fifteen minutes of time to get acquainted with your purchase. These instructions are intended to guide you through connection, operation, trouble shooting, and maintenance.

If you have any questions or problems in start-up, give us a call in Illinois number at 1-630-231-0419

TABLE OF CONTENTS

I. Unpacking, Assembly and Connection . . .	2,3,4,5
A. Unpacking	
B. Electrical Power Requirements	
C. Plug Connection	
D. Adding the Weight Kit and Checking the Nozzle	
E. Checking the Control Box Plugs	
F. Threading the Handle	
II. Operation	6,7
A. Positioning of the Eagle Welder	
B. Master Switch and Control Settings	
C. Seam Start-Up, Window of Weld	
D. Seam Verification	
E. Shutting Down the Welder	
III. General Safety Information	8
IV. Maintenance	9,10
A. Heating Element Replacement	
B. Lubrication	
C. Cleaning	
D. Blower Motor Brush Replacement	
E. Replacement of Screen	
V. Troubleshooting tips	11
Parts List	12,13
Warranty	Back Cover

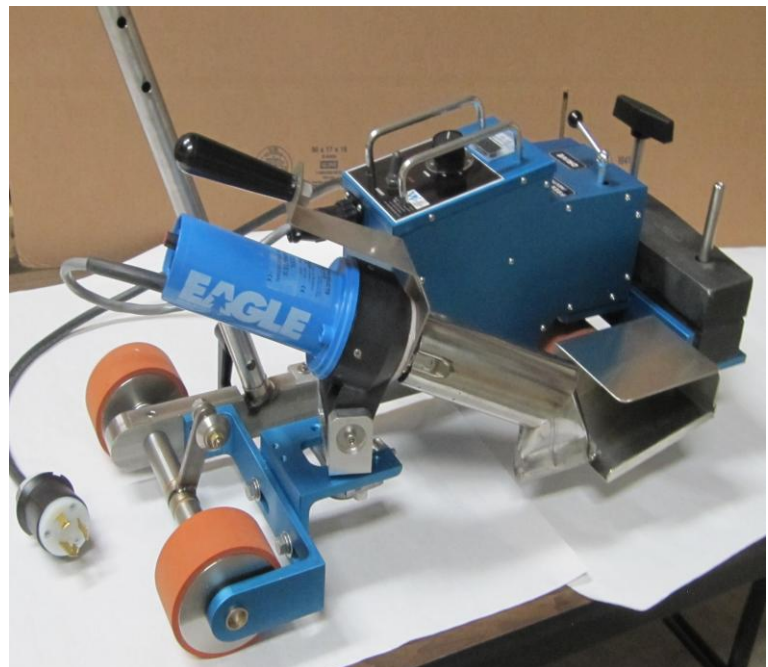

EAGLE TALON 4000

I. UNPACKING, ASSEMBLY AND CONNECTION

A. UNPACKING.

Your new TALON 4000 Hot Air Welder is delivered to you in a sturdy, reusable polymer tool box. The custom designed foam base and spacers assure that your machine is protected and arrives ready to assemble and use.

Remove the handle and the two vertical foam spacers by lifting them straight up. Remove the machine by lifting it straight up and out and set it on a horizontal surface. The 2 additional 10 lb. weights are packed in cut-outs under the machine with foam covers on top.

Remove the foam covers from the weights and place them into the cut-outs for reuse after removing the weights. Return all of the foam pieces to the box for later use during transportation and storage.

The only assembly required is to slip the handle over the tee handle pin on the frame and tighten it down with the safety adjustable handle, and attach an appropriate twist-lock plug to the end of the cord as described below.

B. ELECTRICAL POWER REQUIREMENTS.

(CAUTION): You Are Working with High Voltage Equipment . Death or Serious Injury May Occur During or After Equipment Connection. Utilize a Qualified Electrician.

Rating: 230VAC at 20 AMP The Eagle will operate within a range of 200VAC to 240VAC. Checking the voltage at the point of unit plug-in is critical to the performance of your welder. You can perform the voltage check with built in voltmeter.

Generators: 7,500 Watt Portable Generators should be used as a power source for each Eagle Talon automatic unit in use. Building electrical outlets are a poor source of voltage because they are too unpredictable. Even when they are dedicated circuits, power spikes and drops can occur, resulting in sub-standard equipment operation. A 7,500 Watt capacity for the generator provides a measure of protection against insufficient voltage.

Remember, the Eagle utilizes 4,200 Watts so the gauge and length of your extension cord will affect the wattage requirement.

Extension Cords: *Extension cord should be at least 10 Gauge, 3 wire, grounded cable.* Do not splice lengths of cable together and do not use cables with damaged insulation. This is a serious safety hazard, and can cause a poor connection, resulting in sub-standard machine performance. Some temperature rise on the cord is normal while the welder is operating because of the heavy current conduction. Uncoil the cable if possible to let the cable cool off. Hot cable could cause safety hazard and poor performance.

Keep in mind that a good cable is as important as the generator for the best performance of welder

Maximum Extension Cord Lengths		
Voltage @ power source	10 AWG 3Wire	12 AWG 3Wire
208VAC	100 Feet	50 Feet
220VAC	200 Feet	100 Feet
230VAC	300 Feet	200 Feet
240VAC	400 Feet	300 Feet

C. PLUG CONNECTION.

A Three-prong Twist Lock plug with a rating of 30 Amps and 250VAC is required. Because there are numerous plug configurations, the Eagle is shipped without a plug. A plug with a rating of **30 Amps and 250VAC** must be purchased and properly installed. The purchased plug must fit the generator outlet.

The white and black wires from the cord set of the welder must be connected to the appropriate "X" and "Y" terminals in the plug to obtain the proper voltage. The green wire must be connected to the ground terminal of the purchased plug.

D. ADDING THE WEIGHT KIT, AND CHECKING THE NOZZLE.

If recommended by the membrane manufacturer, add the 20 pound weight kit. Most membrane manufacturers require the weights for welding. The amount of weight is a function of the type of membrane, the type of insulation material and its thickness.

Weight Kit: To add the weight kit, simply slide the two weights over the preinstalled pins on the platform over the pressure wheel. A third 10 pound weight may be added if required.

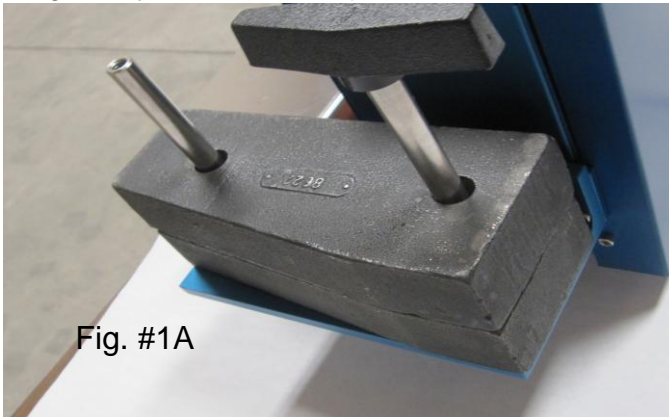

Fig. #1A

Adjust Chain Tension: To adjust the chain tension, simply loosen the bolts and move the assembly until the chain is tight.

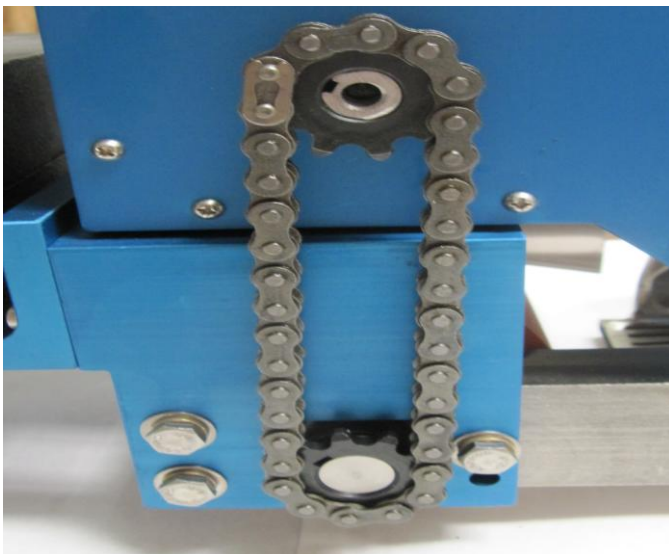
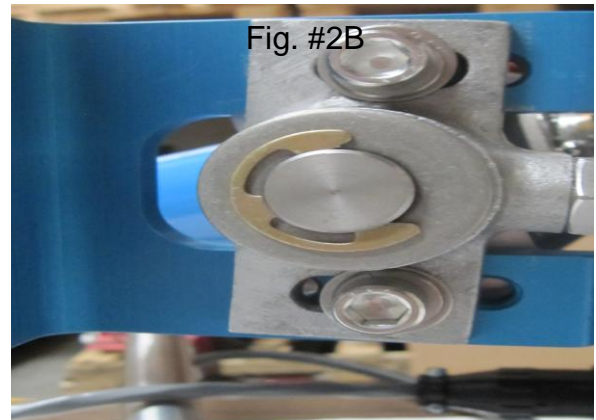
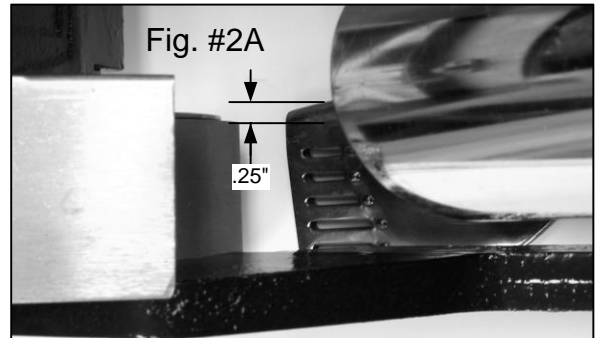
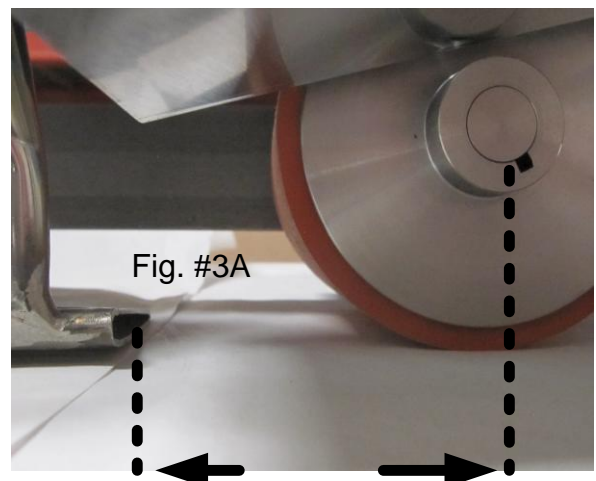

Fig. #1B

Welding Nozzle Alignment: Check the alignment of the welding nozzle to the compression wheel as shown in Fig. #2A. The inside edge of the compression wheel should be in line with the inside edge of the throat of the welding nozzle as shown. Proper alignment of the welding nozzle to the compression wheel is accomplished by adjusting the two bolts on the underside of the unit. Fig. #2B.



Checking the Compression Wheel: Check the distance between the vertical centerline of the compression roller and the tip of the nozzle. The distance should normally be 21/4"-21/2" (55-60mm) from the centerline of the roller. Fig. #2B, Fig. #2C.



E. Gimbal Mount: One of the patented features of this welder is the Gimbal Mount for the welding nozzle assembly. It allows the operator to "SNAP" the welding nozzle in and out of the membrane overlap with a "SNAP" of the wrist. The nozzle may be locked into position by rotating the indexing plunger (Figure 4B & 4C). This keeps the nozzle fixed in position underneath the sheet. When the operator wishes to disengage the nozzle, he simply flips the indexing plunger 90 degrees. The nozzle is now free to rotate out of the weld and into the rest position in the splatter shield..

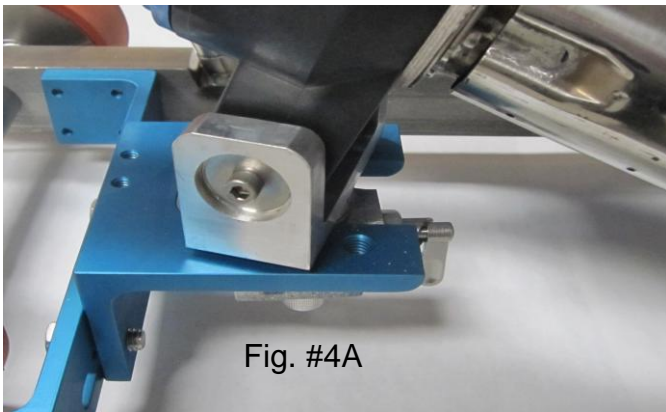

Fig. #4A

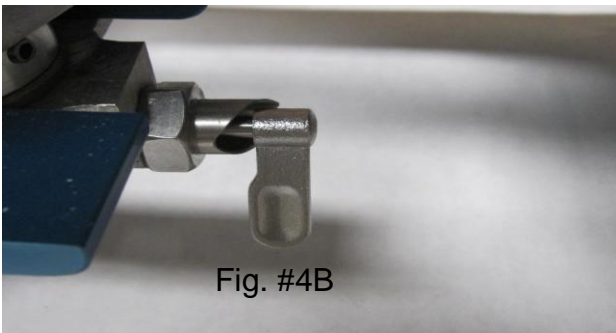

Fig. #4B

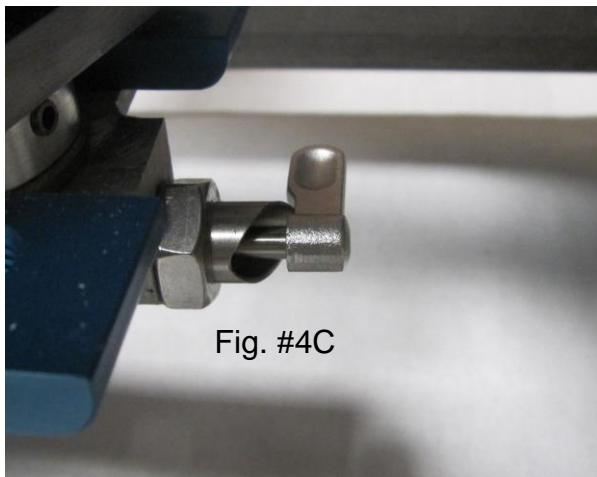

Fig. #4C

F. Heat Gun Assembly Adjustment: The heat gun assembly can be adjusted laterally by loosening the two bolts as shown below. This allows the operator to adjust the heat gun nozzle to be in alignment with the compression wheel.

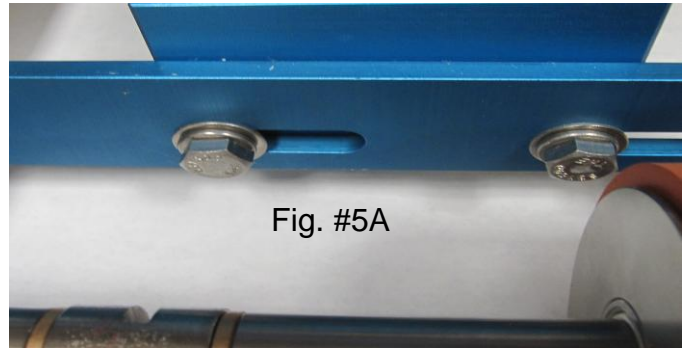

Fig. #5A

G. Guide Wheel Adjustment: The guide wheel can be adjusted so the disk wheel is in line with the edge of the welded sheet. One simply loosens the nut on the left and threads the bolt to the desired position. The guide wheel may also be elevated for re-positioning as show below.



Fig. #6A

Guide Wheel in Down Position

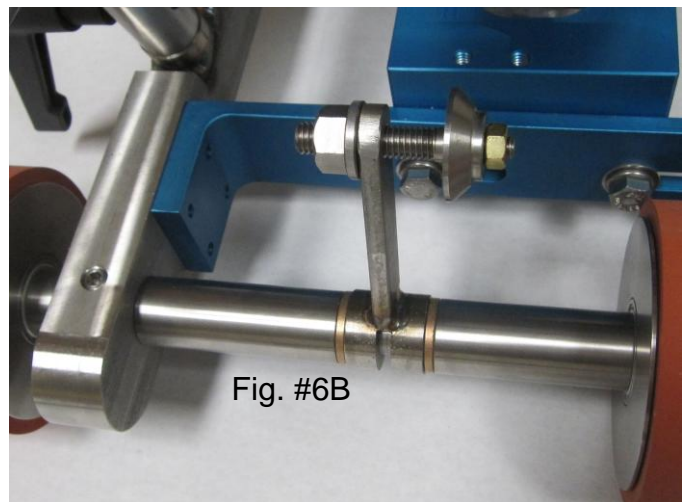

Fig. #6B

Guide Wheel in Up Position

Checking The Control Box Plugs

Each connector is "keyed" or "indexed" for proper alignment when attached.

The drive motor plug should be securely connected to the lower outlet on the left side of the control box.

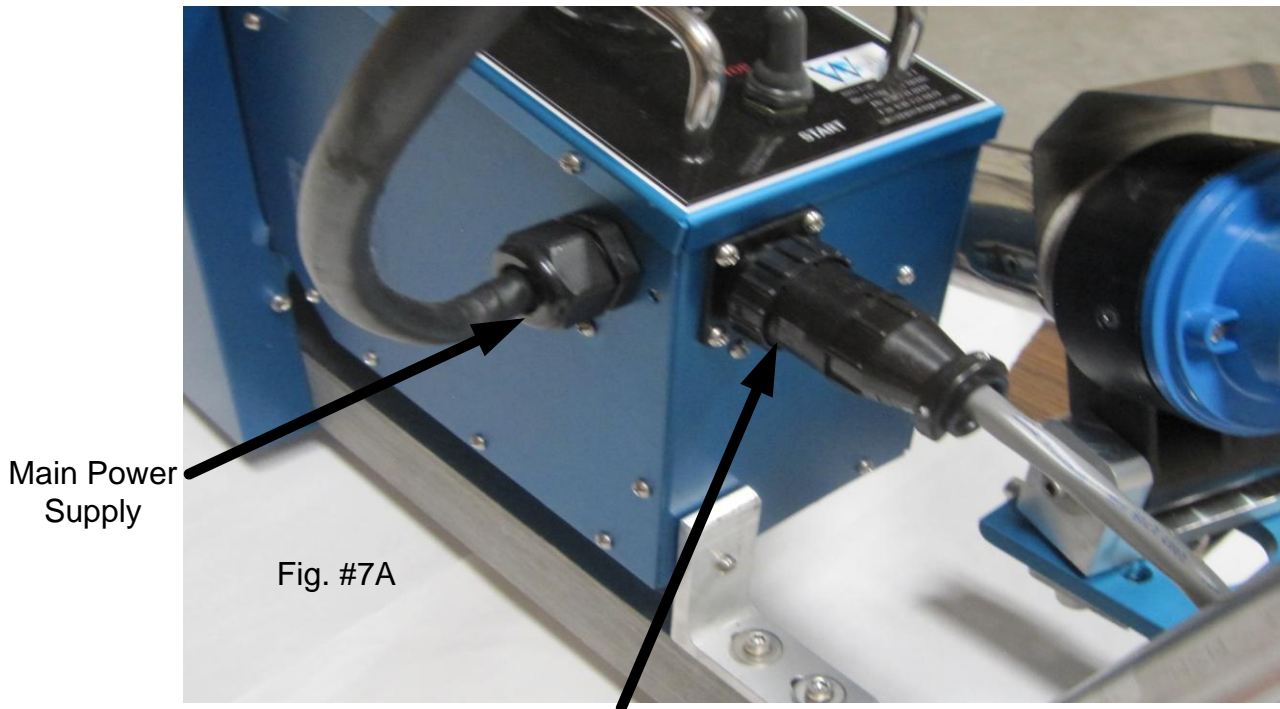
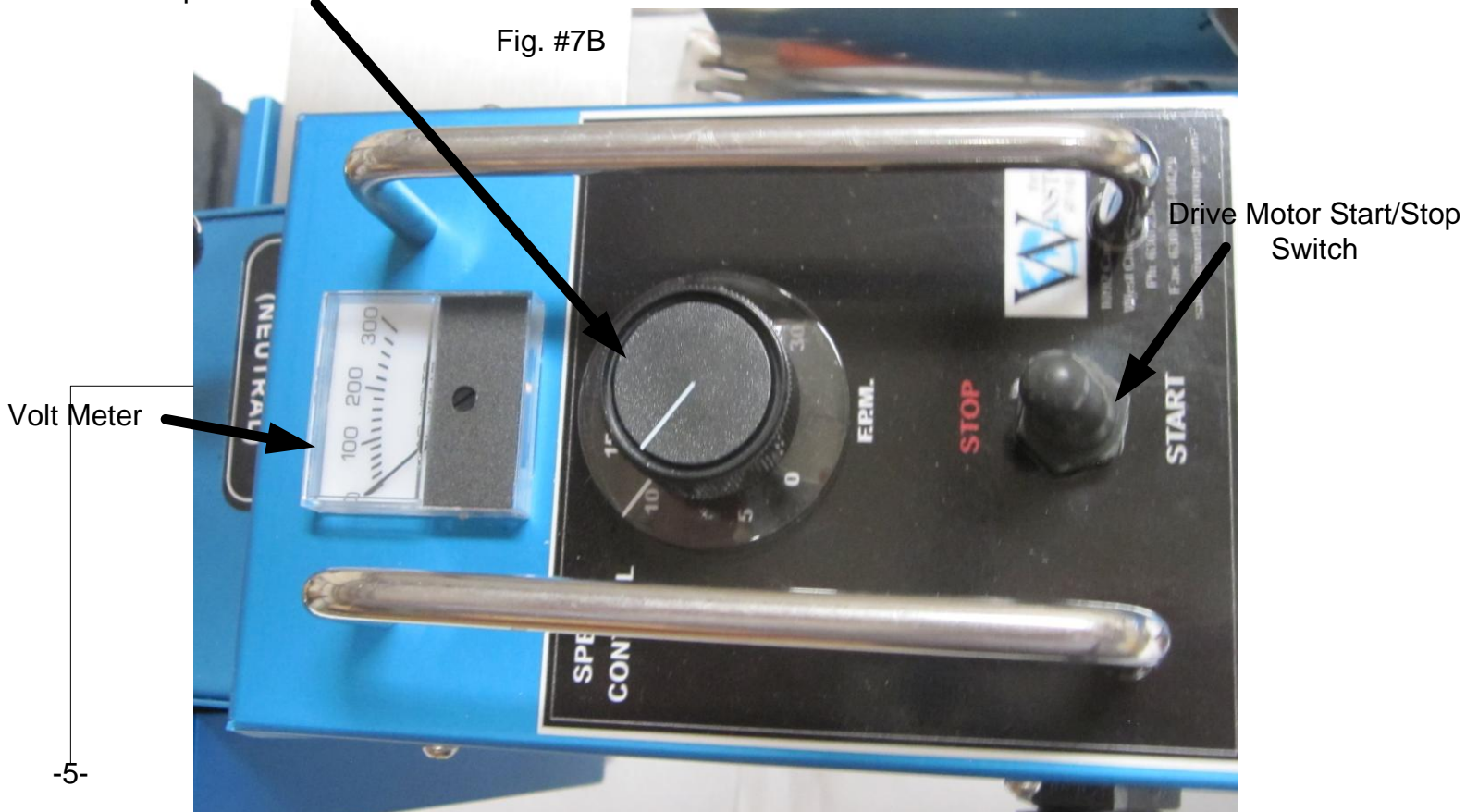

Fig. #7A

Heat Gun Connector

Speed Control Dial

Fig. #7B



Volt Meter

Drive Motor Start/Stop Switch

F. MOUNTING THE HANDLE.

Position the handle over the tee handle pin aligning the holes. Then thread the safety adjustable handle until firmly seated.

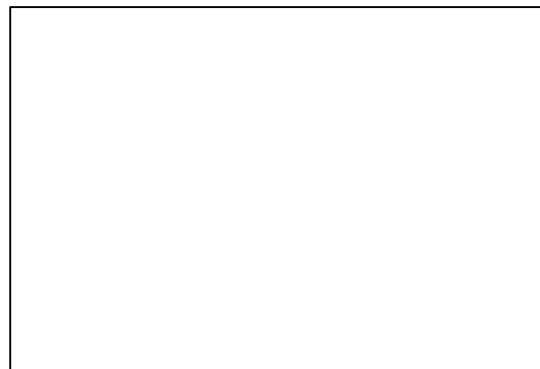

II. OPERATION

A. POSITIONING OF WELDER

Position the unit so that the front compression wheel is sitting entirely on the top of the membrane, approximately $\frac{1}{4}$ " over the edge of the seam. (See Fig. #4).

The unit should be "squared up" so that it will run parallel to the seam. It automatically runs along the lap of the seam.

With a wrench, adjust the tracking guide Part# 8605 in the back of the welder to assist in maintaining a parallel position down the length of the seam. When not in use, make sure that heat gun shoe is resting on the metal resting plate, which protects the pressure roller from burns.

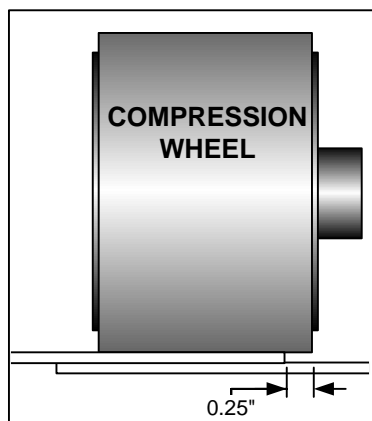

C. SEAM STARTUP, WINDOW OF WELD.

With the unit up to set temperature put the gear arm in to "DRIVE" (See Fig. #9A), turn the drive motor switch to "START" (See Fig. #9A), then position the nozzle tip into the membrane seam and the unit will begin to drive itself.

The operator must assist the welder, guiding it down the length of the seam. Since the operator is walking **BACKWARDS** on the substrate, **CAUTION MUST BE TAKEN AT ALL TIMES** for his own safety.



Fig. #9A



Fig. #9B

WINDOW OF WELD

The Winston Group does not warrant seam performance. Only you can control and verify a quality seam. The operator's selection of speed, temperature, and pressure (weight kit) will vary with the type of membrane, its color, the substrate, and the conditions of the jobsite. In addition, your membrane manufacturer will provide you with a correct temperature and speed guidelines. In the selection of temperature and speed, the experience of the operator and the advice of the membrane manufacturer are the primary sources of information. Always conduct test welds to determine the required settings for the membrane.

REPRESENTATIVE CONTROL SETTING FOR VARIOUS MATERIALS *			
Material	Heat Setting (F°)	Speed Setting (FPM)	Weight (Lb)
APP(Modified Bit.)	1100-1200	8-12	0-30
SBS Modified Bit.)	1100-1200	8-12	0-30

*The values shown are representative for "normal" ambient weather conditions and provided only as a starting point for test welding. The Winston Group does not warranty the weldability and seam strength of any material. The end user must conduct test welding to determine actual control settings.

D. SEAM VERIFICATION.

At the beginning of a day's seam welding, the operator of the unit must always perform destructive seam analysis to make sure that he has selected the optimum mix of temperature, speed and compression for his welder, and the particular membrane. (See Fig. #10A).

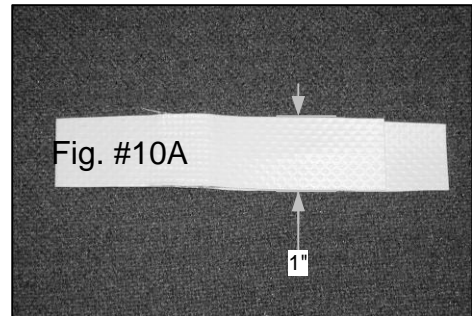

Fig. #10A

Cutting out a 1" by a 6" cross section of the seam and performing a peel of the seam sample should result in the destruction of either the bottom surface of the top membrane or the top surface of the bottom membrane. Where the membrane is reinforced, there should be separation of the weld down to the scrim reinforcement. (See Fig. #10)

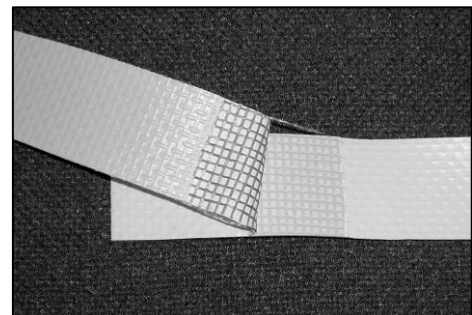

Fig. #10A

If you have concerns about performance of the results see section V. TROUBLESHOOTING TIPS

This seam analysis should be performed at the beginning of a day's production, and at any significant change in operating environment, such as:

- A ten degree (F) change in ambient temperature.
- A significant change in cloud coverage.
- A moderate change in wind conditions (10MPH).
- A moderate change in humidity (10%).
- A noticeable change in the speed of the drive (indicating a significant change in voltage).
- Movement from a major shaded area to a major sunny area, or vice versa.
- Weight change (adding or taking off weights).

The operator should select a mix of speed, weight and temperature that is conservative, that is, he should never run the welder at the "high edge" of welding. There should be a minimum of a 20% margin of safety against peak speed and temperature mix.

The operator should be cautious of poor welds where there is a change in plane of the substrate surface. For example, where there is a seam along the edge of a raised insulation board or where a fastener plate is located too close to the edge of the seam, there may be insufficient compression of the seam.

Start and stop points in a seam are especially vulnerable to cold weld, so these should be marked and checked carefully.

The operator should always "probe" ALL edges of ALL seams to verify welding (See Fig. #11).

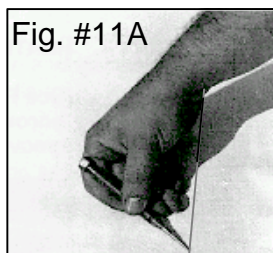

The most common probing method is to run a pointed, metal, hand tool along the edge of the seam with pressure to the tool. Some installers prefer to check seams with a compressed air tool which identifies a seam gap where air enters the seam and flutters the underside of the membrane.

At the end of each 100 foot seam, it is recommended that you wire-brush the bottom of the gun tip to remove any material that may have accumulated in welding. (See Fig. #12A).



E. SHUTTING DOWN THE WELDER.

First, remove the nozzle tip while the welder is still in motion by positioning the nozzle tip in an "UP" position, pointing into the air. **Switch the Drive Motor to "STOP" and put the drive gear lever to "FREE WHEEL".**

DO NOT TURN THE TOOL SWITCH OFF UNLESS YOU HAVE ALLOWED THE GUN TO "COOL" DOWN. Failure to cool the gun prior to turning the power off may cause damage to the unit's heating element and/or internal components. Make sure that the heat of the resting nozzle tip is not pointed in the direction of the weights. Leaving the heat gun in the down position will cause damage to the compression roller.

III. GENERAL SAFETY INFORMATION.

- You are working with high voltage equipment. Always disconnect the power source before servicing the welder.
- Never pull or carry the welder by a power cord or electrical connection.
- Keep clear of the heat gun nozzle. Exposed skin will burn upon contact.
- Always heat seam in a well-ventilated area. Do not inhale fumes caused by the heat seaming process.
- Do not operate near flammable materials. Do not apply any flammable liquids to the surfaces to be heat seamed.
- Always cool the heat gun down before shutting off the master switch. Always cool the unit before storage.
- Protect the unit from exposure to rain. Do not weld when water is standing on the membrane.
- Call if you have questions
1-630-231-0419

IV. MAINTENANCE

A. HEATING ELEMENT REPLACEMENT.

(See Fig. #13 & 14). Disconnect power source. Make sure the unit has thoroughly cooled. Replacement of the heating element is accomplished by removing the four screws at the base of the heat gun nozzle. Before inserting the element, make sure that you align the pins according to key marks on the element and base.



Fig. #13A

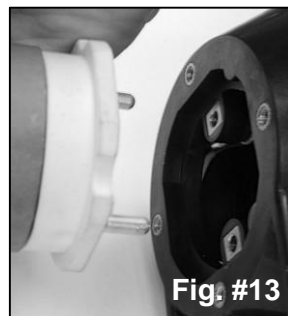

Fig. #14A

C. CLEANING.

Use wire brush at the end of each 100 foot seam to keep nozzle foot clean. (See Fig# 12.)

Check and clean Air Intake screen on back of heat gun handle at least twice a day. Dust and lint will clog the screen. Brush out with a small soft brush, and rotate the baffle. (See Fig#15)

Do not operate unit with intake screen damaged or missing. Material drawn into the heat gun can damage the impellers, controls and heating element.



Fig. #15A

B. LUBRICATION.

Lubricate the following areas once a month with a light lubricating oil (LPS-2 or WD-40, for example):

- Drive axle bushings;
- Pivot shaft of heat gun (remove set screw, spring, and ball and spray directly into hole)
- Chain.

D. BLOWER MOTOR BRUSH REPLACEMENT

Factory installed blower motor has about 1400 hours of brush life. To prevent potential stall problems during welding operation brushes should be replaced after 1000 hours of operation.

To replace the brushes do the following:

1. Turn the power switch off and disconnect power cord from supply.
2. Unplug thermocouple and fan-heating element supply cord.
3. Remove the two #8-32 x 3/8 screws that hold the blower motor housing.
4. Gently slide the motor housing away from the blower motor.
5. Bend the brass flap on the brush holder assembly about 90 degrees at both sides and remove the old brushes.
6. By matching the cylindrical surface of the brushes to the surface of the commutator, load the new brushes into brush holder.
7. Bend the brass flaps back to their original position.
8. Plug the main power and heatgun connectors to the unit and run the blower motor for 3-4 seconds and observe the amount of sparks. If sparks are larger than 1/16" consult the manufacturer. Motor replacement may be needed.
9. Unplug the main power and heatgun connectors and slide the motor housing to the original position. Fasten the mounting screws.

E. REPLACEMENT OF SCREEN.

Air screen should be cleaned as needed to maintain proper air flow to prevent over heating and loss of welding performance. After several cleanings you may need to replace the screen. To replace the screen do the following: (See Fig#16)

1. Turn the power switch off and disconnect power cord from the power supply,
2. Using a small flat tip screwdriver pry off the air damper,
3. Remove the defective screen and make sure there are no pieces of screen remaining inside the motor housing,
4. Place the new screen and air damper (best if both replaced at the same time,

Warning: Never punch the screen with a sharp object to open air path. This will allow airborne particles to get inside of the unit and shorten the life of the moving parts and heating element.



V. TROUBLESHOOTING TIPS

NO HEAT

1. Check heating element by either replacing (see maintenance) or attaching an ohm meter to terminal 2 & 3 (See Fig. #14) of the plug end for a readout of approximately **11.5 ±1 ohms**.
2. Check the temperature sensor by attaching an ohm meter to the two pins in the temperature sensor connector. Readout should be approximately **1.5 ±0.5 ohms @ 72°F**. (See Fig. #3)
3. Check the heat gun motor by connecting ohm meter to terminals 1 & 2 (See Fig. #14) of heatgun assembly plug connector. Readout should be **150 ±10 ohms @ 72°F**.

CAUTION: For measurement, always handle the connectors from indicated twisting section of the plug. (See Fig. #7A). Disconnect main power before unplugging any connector.

POOR WELD .

1. Check power source for 200 to 240 VAC. (See Fig. #7B)
2. Check and/or replace heating element.
3. Gun tip not properly aligned at 2-1/4"-2-1/2". Loosen two bolts on underside of frame and adjust the yoke.
4. Add weight to increase lap compression
5. Incorrect relationship between speed and temperature. Consult membrane manufacturer. You may be moving too fast for your temperature setting.

NOZZLE CRAWLS OUT OF SEAM

1. Tighten set screw at the base of the yoke with a 7/32" Allen Wrench.

UNIT "JERKING"

1. Check for low voltage on the control box voltmeter. (Should be 200 to 240 VAC). (See Fig. #7B)
2. Check drive gear arm.
3. Increase speed setting slightly higher.

CONTAMINATE ALONG LENGTH OF SEAM

1. The compression wheel should be aligned on TOP overlap, 1/4" over the edge of the seam.

WRINKLES FORMING NEXT TO SEAM

1. Too much heat, lower temperature setting.
2. Use least amount of weights. Start with no weights and add-remove weights as required for best results.

Warranty

EAGLE TALON AUTOMATIC HOT AIR WELDER

This product has been manufactured and engineered to the highest performance standards and has been subjected to testing prior to shipment.

ONE YEAR WARRANTY

THE WINSTON GROUP guarantees this product against defects in material and workmanship for a period of ONE YEAR from the established purchase date. The Winston Group will repair or replace, free of charge, any defective parts determined to be covered under this warranty by factory authorized service personnel. Labor to install these parts will be supplied at no charge during this one year period.

The complete unit or defective module must be returned to a factory authorized service center, freight prepaid, preferably with a letter of explanation.

CONDITIONS

This warranty does not apply if the unit has been misused, altered, or used for any purpose other than in accordance with the operating instructions provided. This warranty does not cover transportation, exterior finishes, heating elements, silicone wheels, or carbon motor brushes.

Operation of these units with other than factory original parts shall render this warranty null and void.

This warranty replaces all other warranties expressed or implied.

THE WINSTON GROUP LTD.
1092 CAROLINA DRIVE
SUITE 1
WEST CHICAGO, ILLINOIS 60185
PH: 630-231-0419
FAX: 630-231-0429
E-MAIL: SALES@WINSTONGROUP.COM